

MANUAL

# Super Smart Toilet

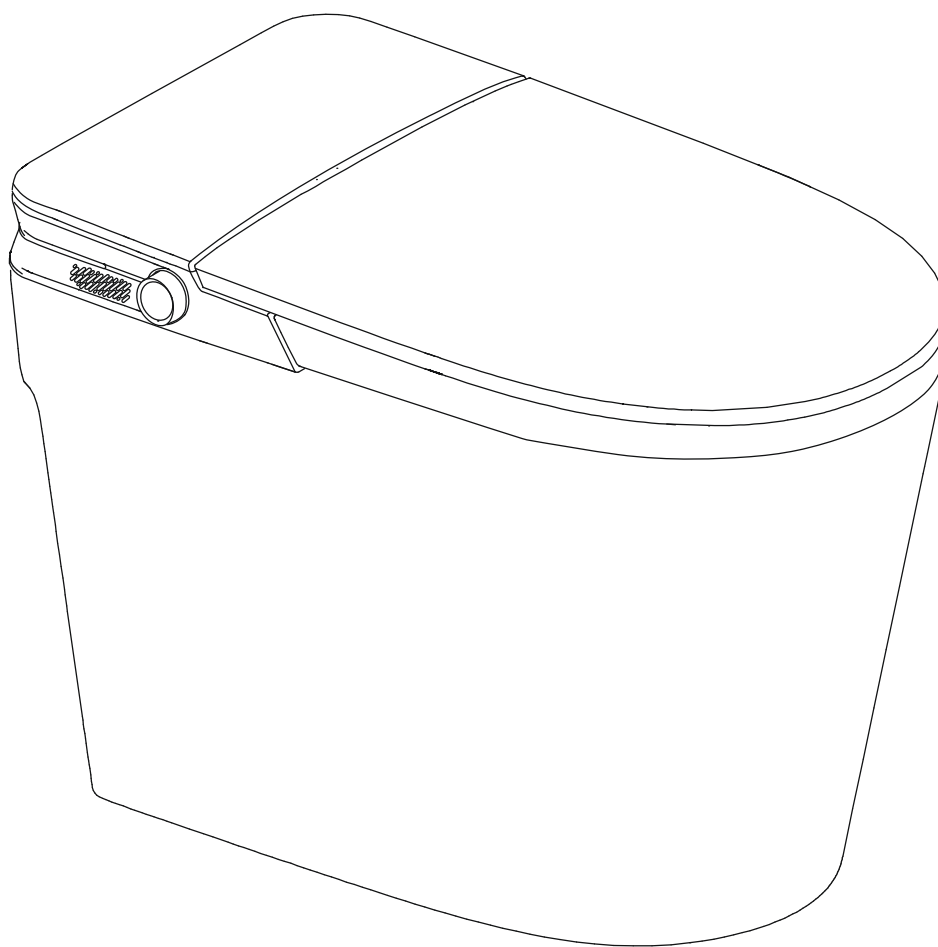

FORNIO  
ACQUA®

CSTE01

# TABLE OF CONTENTS

Important Safeguards.....	2	Remote Control Operation.....	14
Grounding Instructions.....	3	Cleaning and Maintenance.....	15
Tools Required.....	3	Troubleshooting.....	17
Precautions.....	4	Technical Data.....	18
Overall Major Components.....	6	Communication Device Caution.....	19
Exploded View and Package Contents...7		Warranty.....	20
Smart Toilet Installation.....	8	Customer Care.....	21
Testing After Installation.....	9		
Remote Control Installation.....	10		
Functions.....	11		

## IMPORTANT SAFEGUARDS

### SAVE THESE INSTRUCTIONS

When using electrical products, especially when children are present, basic safety precautions should always be followed, including the following.

READ ALL INSTRUCTIONS BEFORE USING



**DANGER - To reduce the risk of electrocution:**

1. Do not use while bathing.
2. Do not place or store product where it can fall or be pulled into a tub or sink.
3. Do not place in or drop into water or other liquid.
4. Do not reach for a product that has fallen into water. Unplug immediately.



**WARNING - To reduce the risk of burns, electrocution, fire or injury to persons**

1. Close supervision is necessary when this product is used by, or near children or disabled people.
2. Use this product only for its intended use as described in this manual. Do not use attachments not recommended by the manufacturer.
3. Never operate this product if it has a damaged cord or plug, if it is not working properly, if it has been dropped or damaged or dropped into water. Call Customer Care or return the product to a service center for examination and repair.
4. Keep the cord away from heated surfaces.
5. Never block the air openings of the product or place a soft material on top of it, such as a towel, clothes or a pillow, where the air openings may be blocked. Keep the air openings free of lint, hair and the like.
6. Never use while sleeping or drowsy.
7. Never drop or insert any object into any opening or hose.
8. Do not use outdoors or operate where aerosol (spray) products are being used or where oxygen is being administered.
9. Connect this product to a properly grounded outlet only. See Grounding Instructions.



# PRECAUTIONS

- Read this manual carefully, so that you can use the product correctly. Read through all the precautions listed here, they are important content related to safety.
- Failure to install the product in accordance with this manual or failure to use the specified components during the installation may cause fatal injuries or accidents.



**Children should only use this product supervised.**

**Temperature settings should be set on low or off when children or elderly people are using this toilet.**

**Do not disassemble, repair or transform the product yourself**

- It may cause fire, electric shock and other accidents or injuries.

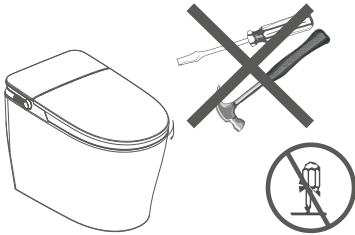

Do not Fix

**Do not pour water or detergent on the product or power plug**

- It may cause fire, electric shock and other accidents or injuries.

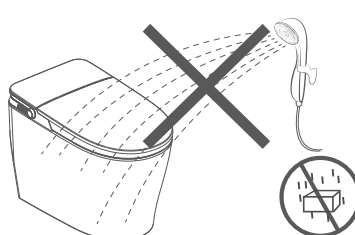

Do not soak

**Use an AC120V,60Hz 15A receptacle.**

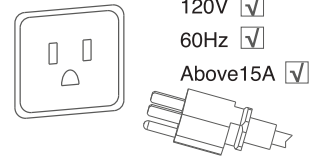

120V

60Hz

Above 15A



Compulsory

**Ground connection: Please ensure that the power receptacle is grounded.**

- Non-grounded receptacle may pose an electric shock hazard.

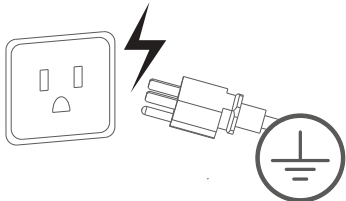

Grounded

**Do not use wet hands to plug or unplug the power.**

- May cause an electric shock.

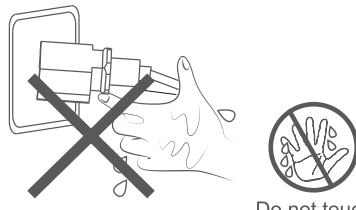

Do not touch with wet hands

**Avoid direct sunlight.**

- The toilet may change color and work incorrectly.



Not Allowed

**Do not use a receptacle that is loose or faulty.**

- May cause fire or electric shock.

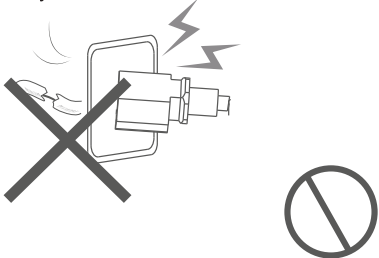

Not Allowed

**Do not place heavy objects or stand on the cover of the toilet seat. Do not hit the product.**

- Product breakage can result in personal injury.

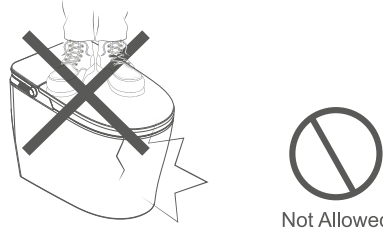

Not Allowed

**Do not put fingers or other objects in the nozzle.**

- May cause electric shock or malfunction.

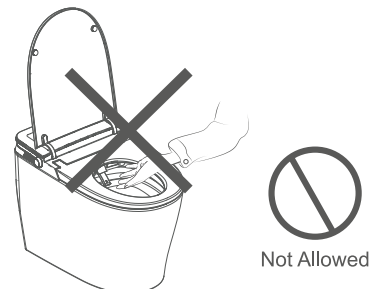

Not Allowed

**Do not remove or replace power cord.**

- If the power cord is damaged, it must be replaced by a licensed electrician.

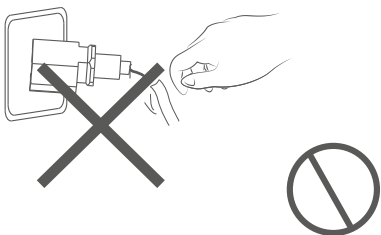

Not Allowed

**Do not twist or break supply line.**

- Otherwise it may cause a leak.

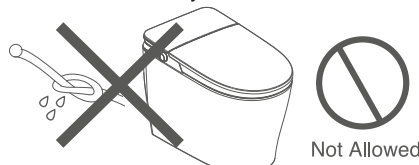

Not Allowed

**Please use new (included) Supply line**

- Old Supply Line will cause the product to malfunction.

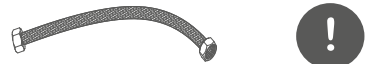

Compulsory

**Do not flush foreign objects**

- it may lead to clogging of the toilet and overflow of sewage.



Not Allowed

**Do not hit the ceramic with metallic objects to prevent leakage from damage.**



Not Allowed

**Do not use below 32°F (0°C).**

● Please refer to the instructions on long-term storage or winterizing below 32°F(0°C).

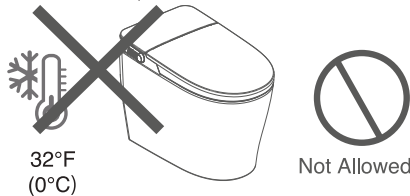

32°F  
(0°C)

Not Allowed

**Only use non-abrasive dish washing detergent for cleaning toilet. Do not use cleaning chemicals for toilets, volatile agents, abrasive cleaners, etc.**



Not Allowed

**Do not flush newsprint, sanitary pads and other articles that may clog the toilet.**

● It may lead to clogging of the toilet and overflow of sewage.

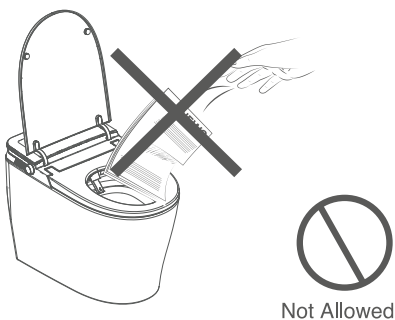

Not Allowed

**Please do not use cloth cover or cushion on seat.**

● Will cause toilet malfunction.

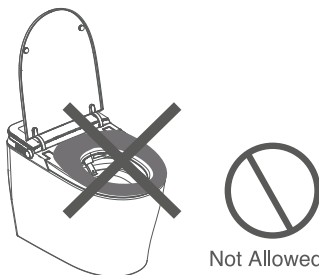

Not Allowed

**Do not force the lid or seat closed.**

● The product may be damaged.

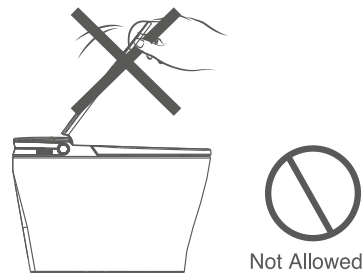

Not Allowed

**Unplug from receptacle for protection against power surges during thunder storms.**

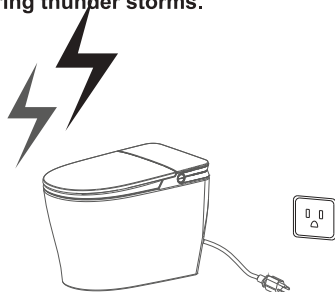

**Unplug the unit if the toilet is backed up.**

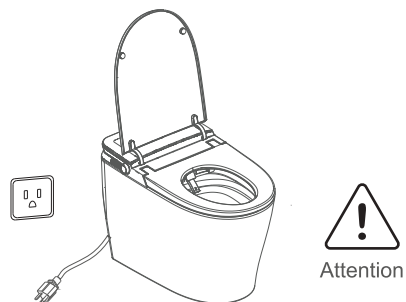

Attention

**Please do not sit or put objects on the lid when it is closed, and do not lean on the lid when it is open.**

● It may damage the lid or it may cause a malfunction.

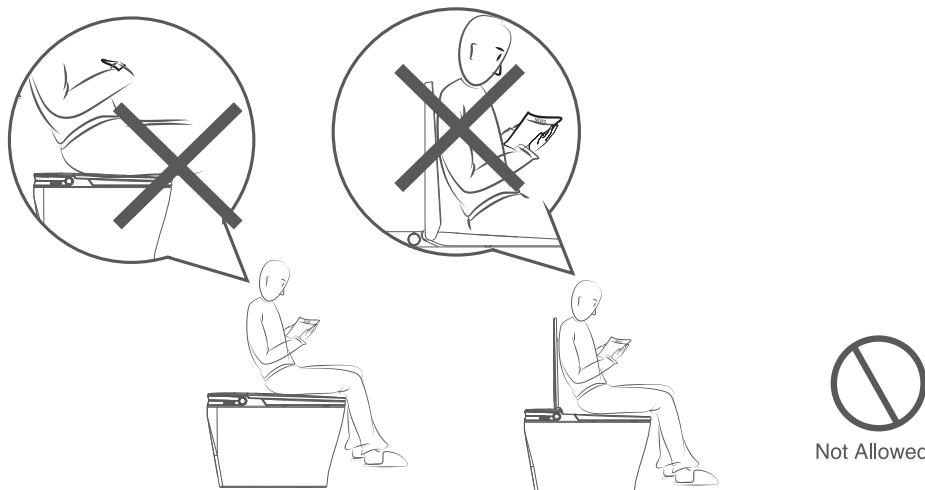

Not Allowed

**Do not damage the power cord.**

1. Avoid exposing the power cord to damage, wear, or excessive heat;
2. Do not bend, kink or pull power cord;
3. Do not place heavy objects or sharp objects on the power cord. Using the toilet with a damaged power cord may result in fire, short circuit, electric shock and other dangerous conditions.

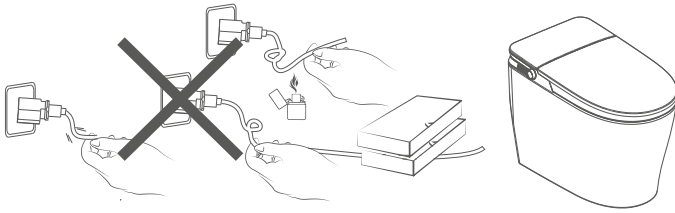

Not Allowed

**This is an electronic product, avoid places of high humidity and direct water splashing. Please install a bathroom fan to maintain good ventilation in the bathroom.**

- Otherwise it could lead to malfunction, fire or electric shock.

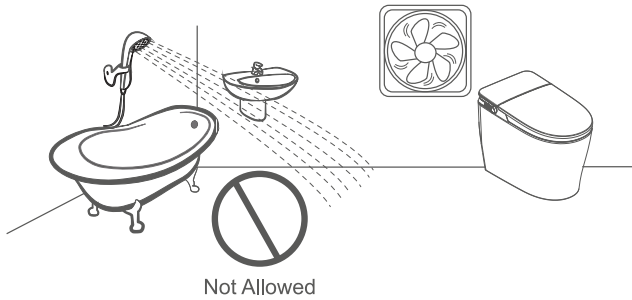

Compulsory

**In case of leakage, close the Angle valve.**

- Avoid flooding, slipping or electric shock.

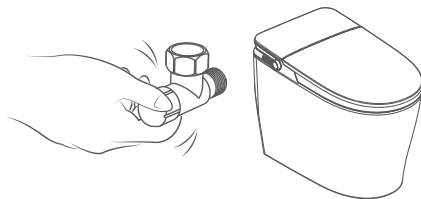

**Prevent damage caused by freezing.**

- Freezing temperatures will cause water in the supply line and in the toilet to freeze causing damage and water leakage.



Attention

## OVERALL MAJOR COMPONENTS

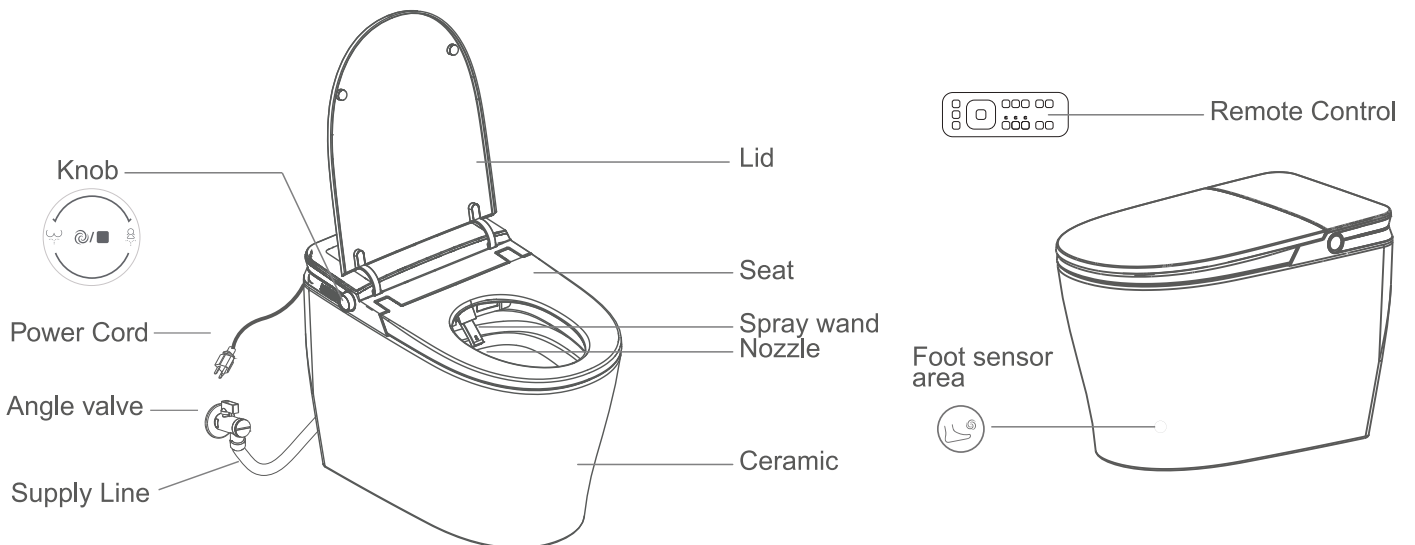

# EXPLODED VIEW & PACKAGE CONTENTS

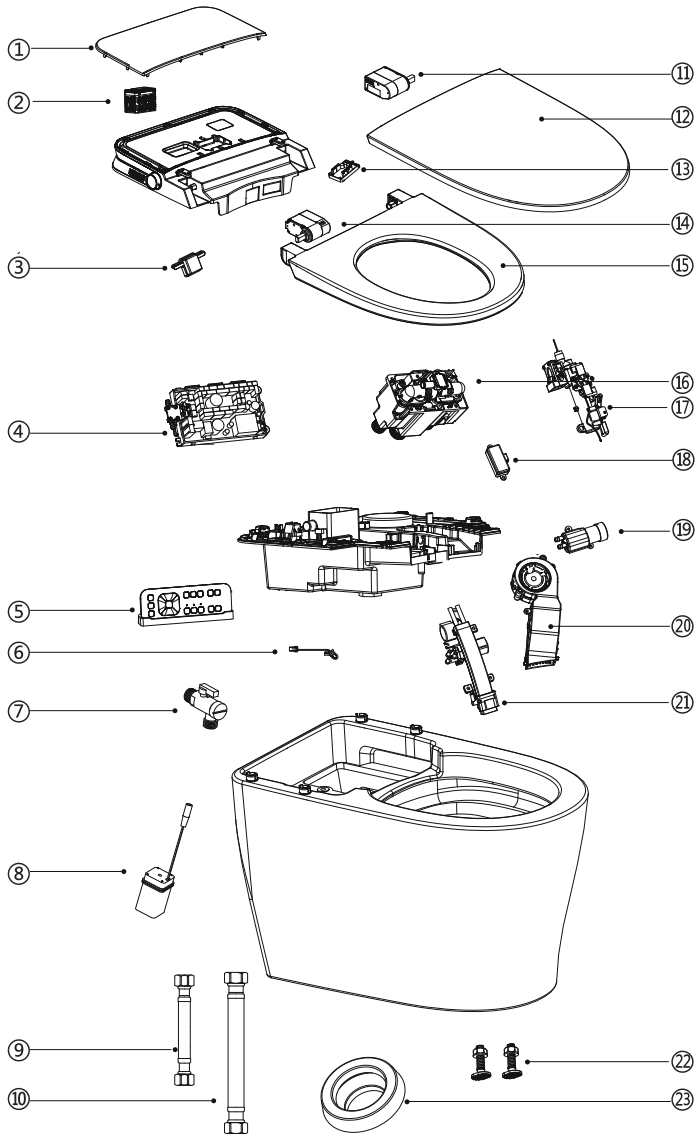

No.	Description
1	Decorative Cover
2	Deodorization Filter
3	Microwave Module
4	Main PCB
5	Remote Control, Bracket & Screws
6	Night Light
7	Angle Valve
8	Battery Pack
9	23" (580mm) Hose (Pre-assembled)
10	28" (720mm) Supply Line (Pre-assembled)
11	Gearbox for Lid
12	Lid
13	Gearbox PCB
14	Gearbox for Seat
15	Seat Rim
16	Flush Valve
17	Instant Heating Module
18	Radio Frequency Module
19	Air Pump
20	Drying Module
21	Nozzle Module
22	Floor Fixing Bolts & Screws
23	Wax Ring

## Package Contents

Description	Qty
Wax Ring	1
Angle Valve	1
Battery Pack (4 X AA Batteries not included)	1
Floor Fixing Bolts & Screws	2
Stainless Steel Hose 23" (580mm)	1
Stainless Steel Hose 28" (720mm)	1
Remote Control (2 X AAA Batteries not included)	1

If you find any part missing, please call: (866) 231 8893  
 Or email us at: [mysupport@fornoworld.com](mailto:mysupport@fornoworld.com)  
 Please do not return this **Super Smart Toilet** to the store before calling

# SMART TOILET INSTALLATION

## Check the Minimum Necessary Water Pressure and Flow Rate

Minimum necessary water pressure: 20psi (0.14Mpa). Minimum flow rate: 4.75gpm (18L/min). The product will not work properly if the pressure or flow rate cannot be reached. (Please refer below if no water pressure test device is available).

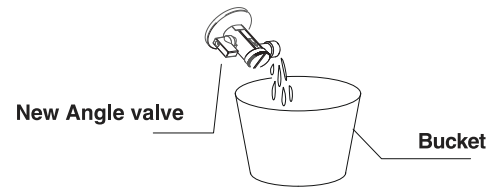

Remove old angle valve and install supplied angle valve. Open new angle valve for 10 seconds. Check water volume. It should be higher than 0.8 Gallons (3 Litres) for the toilet to work properly.

## Confirm Power Supply

The power cord must be plugged into a GFCI receptacle or a receptacle in a GFCI protected circuit complying with: 120V 60Hz and 15A.



120V   
60Hz   
15A Above

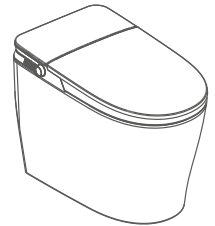
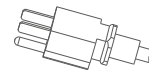

- (1) Do not spray water on the toilet.
- (2) If toilet is below 50°F (10°C), place it in a warm room for 2 hours before installing.
- (3) Failure to comply with the recommendations in the installation manual may lead to personal injury, electric shock or other accidents. Read and follow ALL the manual instructions.

1. Open the lid and the seat. Holding firmly from the seat pull upwards to disengage the cover from the holding clips.

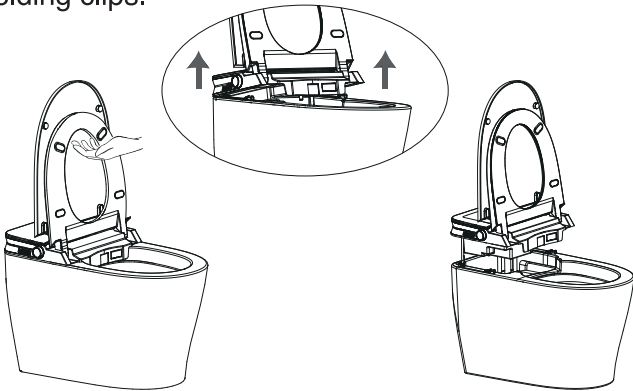

2. Place the installation template as shown below. Confirm rough in pipe. Trace the toilet back and side profile using the hollowed lines on template.

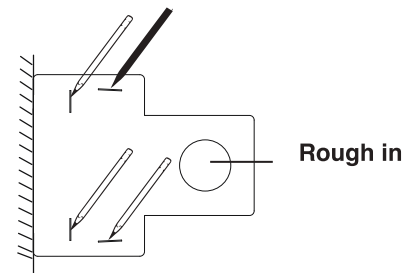

3. Place the bolts into the flange grooves.

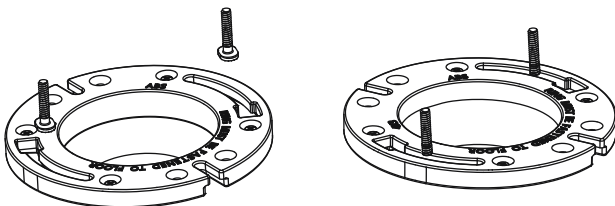

4. Install wax ring centering it on the flange.

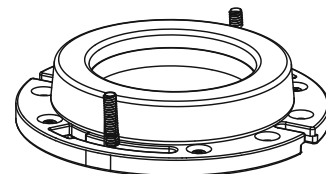

5. Install the ceramic aligning it to the contour lines you traced. **(Note: the fixing bolts need to pass through the holes at the bottom of the ceramic.)**

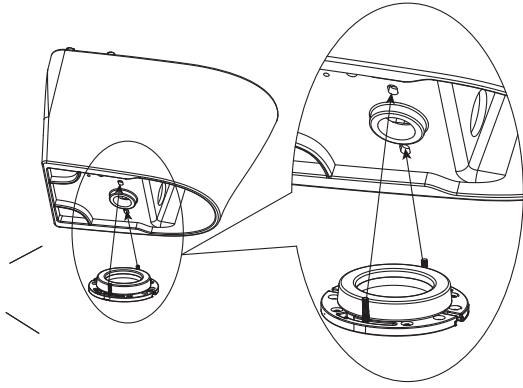

6. Install the washers and locking nuts securing the toilet to the flange.

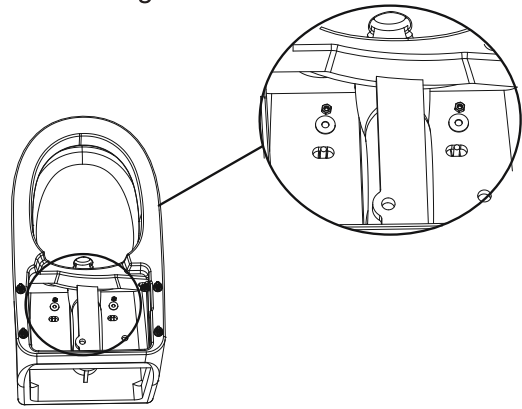

7. Align 4 holding clips in the ceramic with the holes in the back part of the cover and push down.

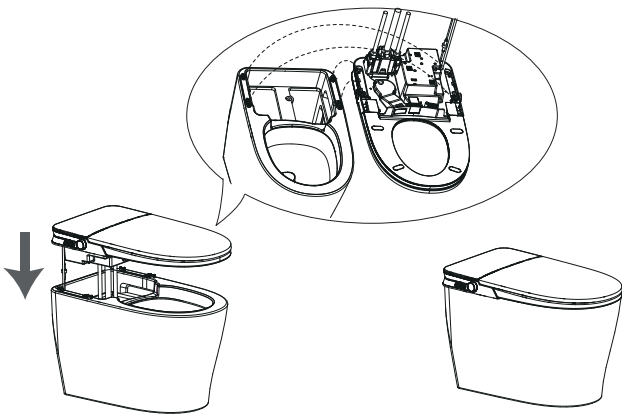

8. Connect the supply line to the angle valve.

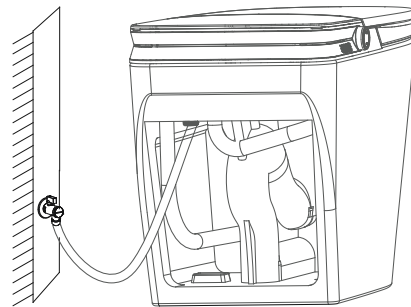

## TESTING AFTER INSTALLATION

### 1. Turn on the angle valve

Open the angle valve a little bit. Check for leaks.

Open the valve completely after checking everything is dry.

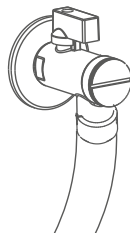

### 2. Product self-diagnosis

After connecting to the power supply, the toilet will give a "beep" sound. Knob light will go on indicating the completion of self-diagnosis.

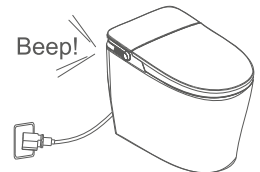

### 3. Flushing test

Press the flush button on the knob to flush the toilet.

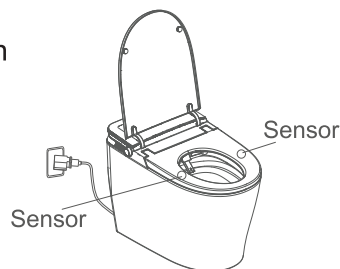

### 4. Drainage inspection

Before applying the caulking, please flush the toilet several times to see if there is any leakage in the ceramic. After inspection caulk around the ceramic. Make sure that the ceramic is sealed in place.

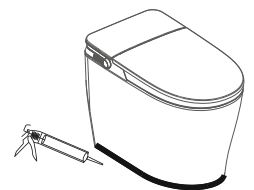

# REMOTE CONTROL INSTALLATION

## 1. Installing remote control bracket

Installation location: The figure shows the recommended installation location for the remote control. The installation location can be selected according to the actual use at home.

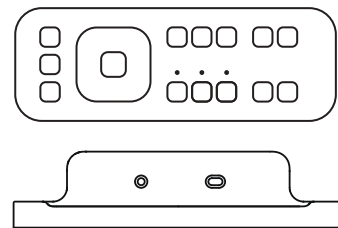
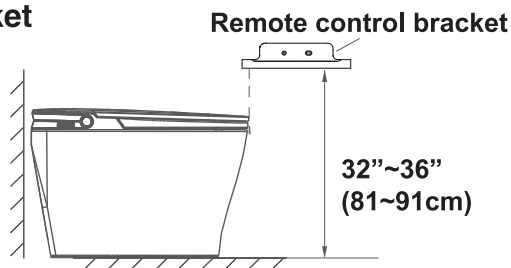

Drill two holes with a diameter of 1/4" (6mm) on the wall with a depth of more than 1-3/4" (45mm). The distance between the two holes should be the same as the distance between the installation holes of the remote control.

Insert the two expansion plugs in the accessory package into the two holes on the wall. Peel one side of the double-sided adhesive tape in the accessory bag and then apply it to the back of the remote control bracket.

Peel the other side of the double-sided adhesive tape and stick the remote control bracket on to the wall aligning the holes of the remote control bracket with the plugs in the wall.

Fix the remote control bracket with the two screws in the accessories package. Open remote control battery cover, put two AAA batteries (not supplied) in and replace battery cover. Follow recommendations in Battery Reminder on page 13. Place the remote control on the bracket.

## 2. Pairing remote control

Under normal circumstances, the remote control can be used normally after battery is set inside it. If the product does not move once it is operated, repair the remote control as follows:

- Unplug the power plug of the toilet.
- Long press the stop button of the remote control until the indicator lights flash.
- Take the remote control close to the Toilet and then plug in the power.
- When the indicator lights stop flashing and stay on, it indicates that the pairing has been successful.

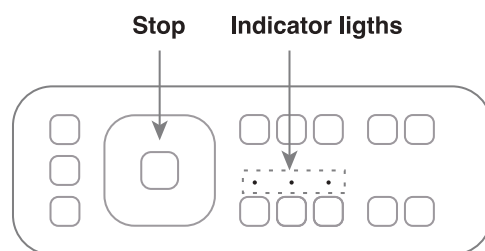

# FUNCTIONS

Function		Elite CSTE01
Heating Mode	FC Instant Heating	✓
Wash	Thermostatic Cleaning	✓
	Rear Cleaning	✓
	Front Cleaning	✓
	Self-Clean Nozzle	✓
	Adjustable Water Temp.	✓
	Adjustable Flow Rate	✓
	Cold & Hot Cleaning	✓
	Child Mode	✓
	Oscillating Wash	✓
Seat	Adjustable Seat Temp.	✓
	Anti-Bacterial	✓
	Sensor	✓
Seat & Cover Open	Remote Seat & Cover Open	✓
	Auto Lid Open	✓
	Foot Sensor Lid/Seat	✓
Light	Night Light	✓
Warm Air	Adjustable Air Temp.	✓
	Start Key	✓
Deodorization	Catalyst Deodorization	✓
Flushing	Off Seat Auto Flush	✓
	Power Off Flush	✓
	Foot Sensor Flush	✓
Controller	Side Knob	✓
	Remote Control	✓
UV Lighting		✓

## Power-on Self-check

1. Each time the toilet is plugged in, all lights will go on, a “beep” will sound and all functions will be reset to factory settings.
2. Water temperature will default to 95°F (35°C); Seat temperature will default to 95°F (35°C).

## Cleaning Function Description

### 1. Rear / Front Bidet cleanse function

When seated, rotating the knob backward (anti-clockwise) will start Bidet rear cleanse. Rotating again in the same direction will start the oscillating wash. If you rotate the knob in the opposite direction, the spray wand will retract to self-clean and then start the Bidet front wash.

When seated, rotating the knob frontward (clockwise) will start Bidet front cleanse. Rotating again in the same direction will start the oscillating wash. If you rotate the knob in the opposite direction, the spray wand will retract to self-clean and then start the Bidet rear wash. Either cleaning modes will stop automatically after three minutes. The toilet will flush, then the drying function will run for 4 minutes.

*\*Both washing and dryer mode can be stopped by pressing the middle of the knob.*

### 2. Self-clean nozzle function

The nozzle will self-clean each time the wash function begins.

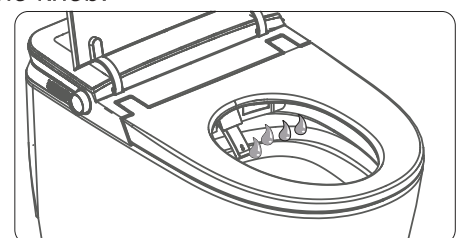
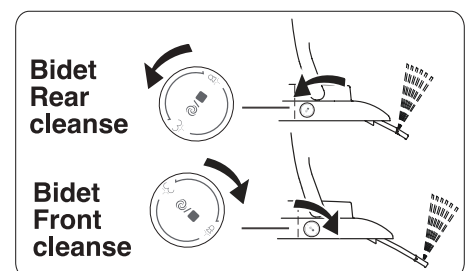

## Knob Operation

Short press  will end any ongoing cleaning/drying/deodorization function; If none of those functions are in progress, the toilet will flush.

While standing, press and hold  to activate Eco mode. To deactivate Eco mode, simply press and hold again while standing.

While seated, press and hold  to activate deodorization mode.



Knob

## Other functions

### 1. Bidet water temperature scalding protection

(a) If the bidet water temperature exceeds 109°F (43°C) during use, the nozzle will automatically retract and switch to continuous self-cleaning mode and give an alarm;

(b) To re-start use, disconnect power supply, wait 10 seconds and re-connect.

### 2. Seat temperature scald prevention function

After sitting down, the system will enter into a seat scald prevention mode automatically.

### 3. Auto lid open function

(a) When a person walks to the toilet and into the sensing area, the lid will open automatically.

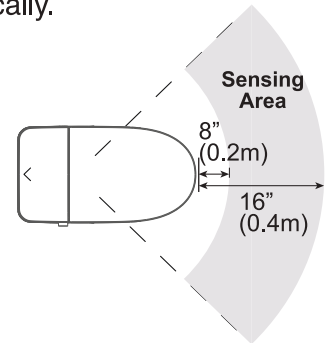

(b) The lid will close automatically 1 minute after a person leaves the sensing area.



### 4. Automatic Flush

The toilet will close seat, close lid and flush automatically 1 minute after a person leaves the toilet sensing area (If a flush is executed before the lid is closed, the toilet will not flush automatically again.)

### 5. Microwave sensor distance adjustment (default first level, 8"~16")

Long press the  button on the remote control to go into the distance setting mode. After that, each time you long press the  the sensor distance will increase and loop between:

1st level, 8"~16" (0.2m to 0.4m). You will hear "beep".

2nd level, 8"~31" (0.2m to 0.8m). You will hear "beep", "beep".

3rd level, 8"~47" (0.2m to 1.2m). You will hear "beep", "beep", "beep".

After 10 seconds that the  is not pressed, the unit will go back to its normal operating mode and the distance setting will be saved.

### 6. Foot sensor lid/seat open and flushing function

(a) When both the lid and seat are closed, the lid will open automatically once the user touches the foot sensor area.

(b) When the lid is open and seat is closed, the seat will open automatically once the user touches the foot sensor area.

(c) When the lid and seat are open, both of them will close and start a small flush once the user touches the foot sensor area.

(d) If someone that has been sitting in the seat for under 2 min. touches the foot sensor, the lid will close and a small flush will start.

(e) If someone that has been sitting in the seat for over 2 min. touches the foot sensor, the lid will close and a large flush will start.

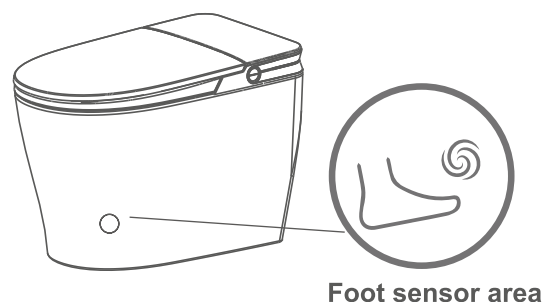

Foot sensor area

## 7. Automatic Deodorization

When the device is in the powered - on state and a person is seated, the deodorization fan will automatically turn on.

When a person leaves the seat, the deodorization fan will remain on and automatically turn off after one minute.

When the flushing is working, the deodorization fan will stop.

## 8. ECO Mode

When the unit is set to Eco Mode, the following changes will occur:

(a) Lighting: The knob and bowl lights will turn off.

(b) Sensors: The microwave sensors will deactivate, disabling automatic lid and seat opening as well as automatic flushing. You will only be able to flush the toilet using the knob, remote, or foot sensor.

(c) Seat Temperature: The seat temperature will be set to the lowest setting. Once a person sits on the toilet seat, it will gradually return to the previous temperature setting. When the person leaves it will go back to the lowest setting again.

(d) Deactivating Eco Mode: The toilet will then revert to its previous settings (to deactivate Eco Mode, press and hold the knob  while standing).

## 9. Power off flush function

When power is off, the battery pack will take over. Short press the knob to flush. No other function will work. The batteries should last for 100 flushes.

Changing / Inserting Batteries:

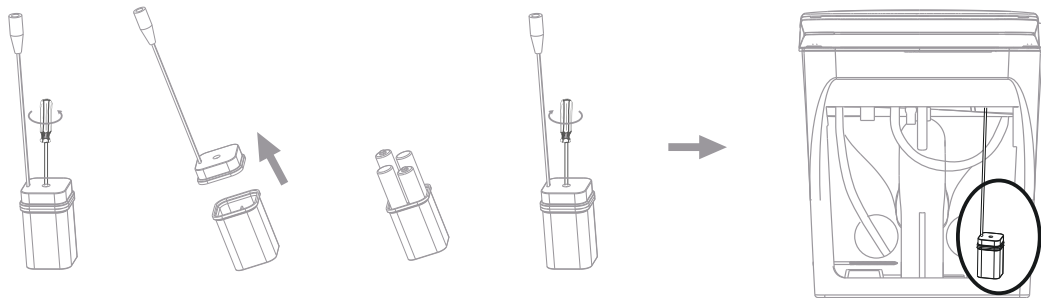

(a) Open the battery pack with a Phillips screwdriver.

(b) Remove the battery tray.

(c) Following recommendations in Battery Reminder below, load 4 size AA batteries (not supplied) into the battery tray being careful with the polarity of the batteries.





(d) Re-assemble the battery pack and install in the toilet.

### BATTERY REMINDER

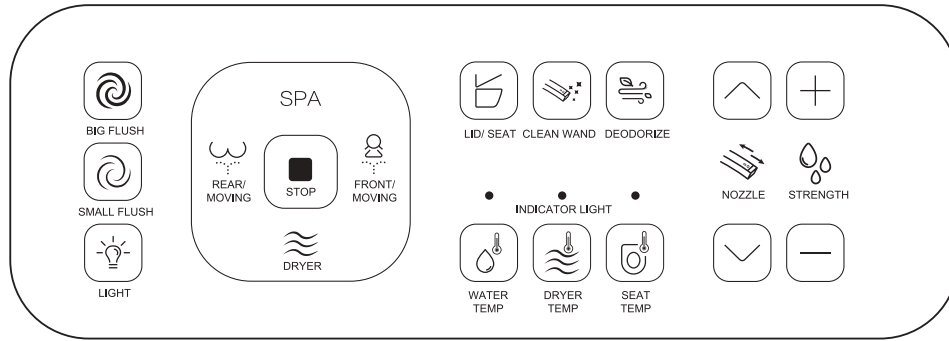
1. This toilet is designed to flush using batteries only during a power outage. Check batteries at least once a year to ensure they are in good working condition.
2. Strictly follow the "+" and "-" signs in the battery pack when inserting batteries. Reverse connecting batteries may cause battery damage and safety hazards such as explosion or combustion.
3. Only size recommended batteries should be used. Old and new batteries should not be mixed. Different models and brands of batteries should not be mixed. When replacing batteries, all of them should be replaced at the same time.
4. Clean the battery contacts and also those of the device prior to battery installation.
5. Remove batteries from equipment that is not to be used for an extended period of time.
6. Remove used batteries promptly.
7. Handle battery pack with care. After replacing the batteries, make sure the battery pack is securely locked and sealed to prevent bathroom moisture from entering the compartment (this could cause battery corrosion and damage).
8. When replacing batteries, disconnect the battery compartment from the main unit.
9. DO NOT USE RECHARGEABLE BATTERIES.

## Remote Control Operation



1. Short press  to start a big flush.
2. Short press  to start a small flush.
3. Short press  to alternately have the Knob light and the toilet light ON (default) if you press again both will be turned OFF.
4. While sitting in the toilet seat, press  to begin the Bidet REAR wash. If you press it again wash oscillates. If you press it again the oscillation stops but the wash continues.





While sitting in the toilet seat, press  to begin the Bidet FRONT wash. If you press it again wash oscillates. If you press it again the oscillation stops but the wash continues.

During the washing process you can:

- Short press  to set the water temperature according to the following cycle:



The last water temperature setting will be remembered by the system.

- Nozzle position can be adjusted forward by pressing  and backwards by pressing . There are 5 positions available.
- The washing water pressure can be adjusted by pressing  or . There are 4 pressures available.
- Short press “SPA” and the water pressure will begin to cycle between the highest and the lowest pressure. The water temperature will also cycle between the highest and lowest temperature.
- If you press the “SPA” button again the wash will continue at the levels you were at the beginning.
- At any time during Bidet washing you can press  or stand up, the water flow will stop and the nozzle will retract.

5. While seated, short press  to start the warm air drying function.

During the drying process process you can short press  to set the air temperature according to the following cycle:



The last air temperature setting will be remembered by the system.

6. Short press  to set the seat temperature according to the following cycle:





The last seat temperature setting will be remembered by the system.

7. If the top lid is closed, you press  the lid will open.

If the top lid is open, you press  the seat will open (no action will happen if there is a person seated).

If the lid and the seat are open, you press  the seat and lid will close.

8. When you press  the nozzle will self clean first and then extend to allow for manual cleaning.  
After 15 minutes the nozzle will retract automatically.

9. Short press  to start the deodorizing function.

Long press  to toggle between ON/OFF the automatic deodorizing function.

10. Long press  to enter children's cleaning mode. The water, air and seat temperatures will all go to the mid range. The nozzle will extend to the furthest front position. The cleaning water pressure will be set to the lowest setting.

Press  to finish and exit the children's cleaning mode.

11. Other key functions:

Long press  turn on/off Prompt Sound.

Long press  turn on/off Automatic Seat.

Long press  turn on/off Foot Touch Sensor.

Long press  turn on/off Off seat Automatic Flush.

## CLEANING AND MAINTENANCE

### 1. Maintenance of product surface and ceramics

The detachable accessories can be removed before maintenance.

Note before maintenance:

(1) Make sure the power supply is disconnected.

(2) Do not let water enter the product during the maintenance process.

(3) Be sure to wipe off any detergent after cleaning to avoid residue at the gap between the main ceramic body and the cover.

#### Product surface cleaning

Wet a soft cloth with water, wring it, and then wipe the product. If the toilet is dirty, you can use a soft cloth with a little diluted neutral detergent to clean it. Then use a clean damp cloth to wipe it clean.

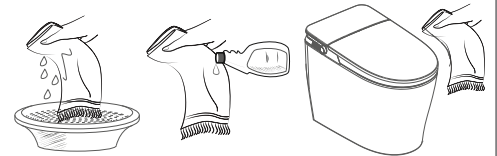

### 2. Maintenance of the nozzle

(1) Press the  for the nozzle to self clean first and then extend to allow for manual cleaning. After 15 minutes the nozzle will retract automatically.

(2) Dip a soft cloth, sponge or small brush in neutral detergent, then hold the wand to wipe it and the nozzle.

(3) Press any key to exit the mode after cleaning.

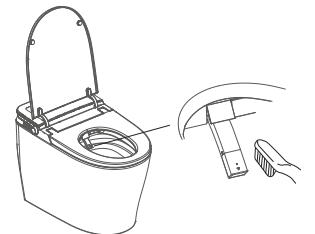

### 3. Maintenance of valve if water performance is low

(1) Turn off the angle valve. Unscrew the filter screen cap at the front of the valve with a straight screwdriver.

(2) Use a small brush to scrub the filter screen, and flush away debris with clean water.

(3) Reinstall the filter on to the angle valve and tighten it.

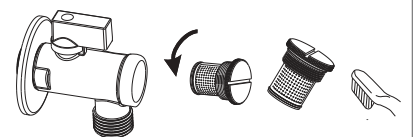

#### 4. Deodorization Filter

Open the decorative cover and change the deodorization filter. The deodorization filter need to be replaced every year to maintain full deodorization power.

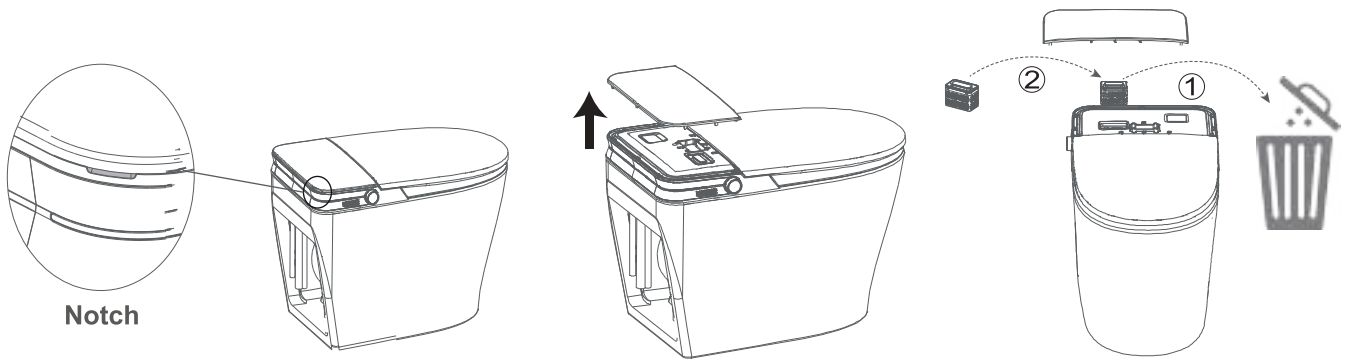

# TROUBLESHOOTING

ISSUE	PROBLEM	CHECK	SOLUTION
1. General	The toilet does not work	Check whether cloth covers, cushions, etc. are being used on the seat sensing area.	Remove cloth covers, cushions or any other items.
		Check if there is a power outage.	Wait for power supply recovery.
		Check if the plug is loose or making poor contact.	Plug in to ensure good power supply.
		Check if there has been electricity leakage (the GFCI receptacle indicator light is off or the GFCI breaker has tripped).	Unplug the power plug. Press the reset button on the GFCI receptacle or reset the GFCI breaker. If it still does not work, contact customer service.
2. Bidet	No water comes out of the nozzle when the knob is turned	Check if there is water supply to the home	Wait for home water supply to return
		Check if angle valve is closed or blocked with debris.	Open angle valve. If open, refer to Maintenance of the Valve.
		Check if the supply line is bent or kinked.	Straighten supply line.
	The nozzle wand does not extend after turning the knob	No one is sitting on the seat.	Change position on the seat so that at least one of the sensors is being touched. Once that is achieved there will be a beep prompt. Turn knob again and the wand should extend.
		Person sitting on the seat is not touching either of the seat sensors.	
	Water drips from nozzle when not in use. No alarm sound.	Solenoid valve has failed.	Contact Customer Service.
	The nozzle wand extends too slowly	Take into consideration the self-cleaning time.	The whole cleaning and extension of the wand should take 7 seconds.
	Not enough water	Blocked filter	Refer to Maintenance of the Valve.
While someone is washing the alarm sounds and there is continuous dripping. The remote control buttons stop working.	The hardware has failed or the safety protection has been triggered.	Stop using unit. Unplug it wait for 20 seconds and replug it again. If the problem persists call customer service.	
Lower water temperature	Check the setting of the water temperature with your remote.	Change setting to what you would like to have.	
3. Flushing	Automatic flushing is not working	Check if the Eco mode has been engaged.	Deactivate the Eco mode by pressing the knob and holding it for 3 seconds.
		Unplug unit, wait for 20 seconds and plug. Check if the problem still persists.	Contact Customer Service.
	The toilet does not flush	Angle valve is closed. The filter is blocked.	Open the angle valve. Refer to Maintenance of the Valve.
	The toilet does not flush properly	The filter is blocked.	Refer to Maintenance of the Valve.
4. Seat	Automatic seat is not working.	Check if the Eco mode has been engaged.	Deactivate the Eco mode by pressing the knob and holding it for 3 seconds.
		Unplug unit, wait for 20 seconds and plug. Check if the problem still persists.	Contact Customer Service.
	The seat is not heating.	Check if the seat temperature is set to low or off. Check if there is power outage.	Reset the seat temperature using the seat temperature knob. Wait for power supply recovery.
5. Drying	No response when pressing warm air button.	Person must be seated with the sensors engaged for the warm air function to work.	Start warm air while seated. Engaged either one of the seat sensors.
	No warm air or temperature change when warm air is on.	Thermostat is offline.	Stop using unit. Unplug it wait for 20 seconds and replug it again. If the problem persists call customer service.
		Fuse has burnt.	Call Customer Service.
6. Lights	Toilet light and knob light does not work.	Check if the Eco mode has been engaged. Check if the fault still exists after doing a reset by unplugging, waiting 20 seconds and re-plugging unit.	Contact Customer Service.

## TECHNICAL DATA

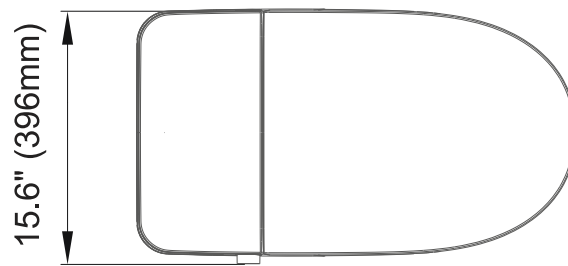
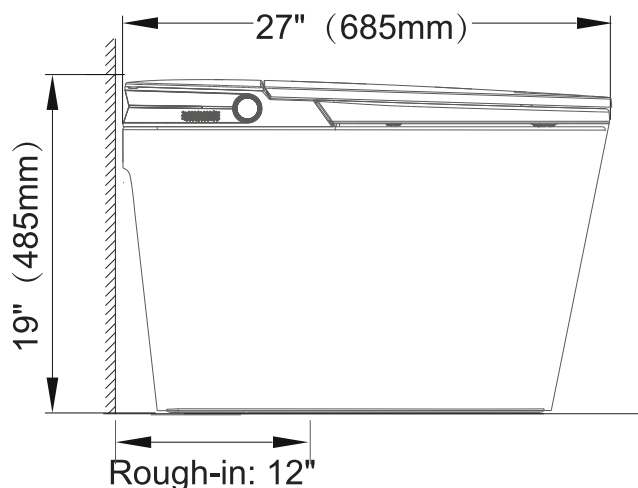

Items		Elite CSTE01
Rated Voltage		120V ~ 60Hz
Rated Power		1,050W
Max. Instantaneous Power		1,350W
Power Cord Length		35.83" (0.91M)
Water Supply Pressure		Min. Dynamic Pressure: 20PSI (0.14MPa) Max. Static Pressure: 110PSI (0.75MPa)
Water Supply Temperature		41~95°F (5~35°C)
Waterproof Level		IPX4
Toilet Flush		≤1.26G (4.8L)
Cleaning Device	Water volume adjustment	4 levels in total
	Water temperature adjustment	4 levels: 91°F/95°F/99°F/OFF (33°C/35°C/38°C/OFF)
	Heating method	Instant heating
	Anti-backflow device	Anti-siphon valve
	Safety equipment	Double thermostat + pressure relief valve
Seat Ring Heating	Heater power	Max.50W
	Safety equipment	Thermostat + fuse
	Surface temperature	4 levels: 91°F/95°F/99°F/OFF (33°C/35°C/38°C/OFF)
Warm Air	Heater power	Max.300W
	Safety equipment	Thermostat + fuse
	Warm air temperature	4 levels: 91°F/99°F/109°F/OFF (33°C/38°C/43°C/OFF) *Test at an ambient temperature of 73±3.6°F (23±2°C)
Deodorization	Deodorization method	Catalyst
Others	Antibacterial material	Seat ring
	Low temperature scald protection	Available
	Prompt for abnormalities	Alarm sound
	Seat sensing	Available
	Lighting control	Available

## COMMUNICATION DEVICE CAUTIONS

The FCC and the IC require for us to place the following warnings in the manuals of every communication device that is tested to meet their standards:

### **FCC Compliance**

Warning: Changes or modifications to this unit not expressly approved by the party responsible for compliance could void the user's authority to operate the equipment.

NOTE: This equipment has been tested and found to comply with the limits for a Class B digital device, pursuant to Part 15 of the FCC Rules. These limits are designed to provide reasonable protection against harmful interference in a residential installation. This equipment generates, uses and can radiate radio frequency energy and, if not installed and used in accordance with the instructions, may cause harmful interference to radio communications.

However, there is no guarantee that interference will not occur in a particular installation. If this equipment does cause harmful interference to radio or television reception, which can be determined by turning the equipment off and on, the user is encouraged to try to correct the interference by one or more of the following measures:

- \* Reorient or relocate the receiving antenna.
- \* Increase the separation between the equipment and receiver.
- \* Connect the equipment into an outlet on a circuit different from that to which the receiver is connected.
- \* Consult the dealer or an experienced radio/TV technician for help.

This device complies with Part 15 of the FCC Rules. Operation is subject to the following two conditions:

1. This device may not cause harmful interference, and
2. This device must accept any interference received, including interference that may cause undesired operation.

Caution: To maintain compliance with the FCC's RF exposure guidelines, place the product at least 20cm from nearby persons.

### **IC Compliance**

This device has been tested to meet Industry Canada technical specifications. This device contains licence-exempt transmitter(s)/receiver(s) that comply with Innovation, Science and Economic Development Canada's licence-exempt RSS(s). Operation is subject to the following two conditions:

1. This device may not cause interference.
2. This device must accept any interference, including interference that may cause undesired operation of the device.

To maintain compliance with the RF exposure guidelines, place the product at least 20cm from nearby persons.

Complies with: CAN ICES-003 (B) / NMB-003 (B)

# Warranty

CTM Maison Elite Inc. grants this limited warranty to the original purchaser of this **Smart Toilet** from the date of purchase. Proof of purchase is required when requesting any warranty assistance.

Limited Two Years: CTM Maison Elite Inc. warrants that all parts, to be free from defects in workmanship and material at the time of manufacture for a period of two years. We agree to send a replacement part without charge or at our option replace it with a comparable or superior part at our sole discretion.

To the extent permitted by law, CTM Maison Elite Inc. disclaims any and all warranties, including but not limited to those of merchantability and fitness for a particular purpose. There is no other express warranty. The duration of any implied warranty which cannot be disclaimed is limited to the period specified in the express warranty. Some states do not allow a limitation on how long an implied warranty lasts. The time limitation may not apply to you. Some states do not allow the exclusion of incidental or consequential damages, so the above limitation may not apply to you. This warranty gives specific legal rights. You may also have other rights which vary from state to state. The retailer shall not be liable for incidental, consequential, or damages arising out of or in connection with product use or performance except as may otherwise be accorded by law.

This limited warranty is non-transferable and only to the original purchaser of this **Smart Toilet** and will be void if unit is removed from its original installation.

This warranty does not cover: ordinary wear and tear, minor cosmetic blemishes, refurbished units, ceramic toilets that are not owned by the original purchaser, acts of God, changes in finish including rusting, pitting, corroding, tarnishing, or peeling.

Damage to any part by accident, misuse, abuse, improper installation, dents and/or scratches incurred during shipping, handling, or installation, bends or warping caused by forced connections, over-tightened fittings, and/or inadequate support during installation, improper care and maintenance, failure to follow the instructions in the enclosed manual or any modification to the unit are not covered by this warranty.

All costs of shipping parts, removing, repair labour and reinstalling the product are not covered by this warranty. Please do not ship your stainless steel sink or any parts to CTM Maison Elite Inc. Shipment will not be accepted.

This warranty supersedes all prior warranties.



# Customer Care

Thank you for purchasing a FORNO ACQUA product. Please read the entire instruction manual before operating your new Smart Toilet for the first time. Whether you are an occasional user or an expert, it will be beneficial to familiarize yourself with the safety practices, features, operation and care recommendations of your Smart Toilet. Both the model number and serial number are listed on the product. For warranty purposes, you will also need the date of purchase. Record this information below for future reference.

## SERVICE INFORMATION

Model Number

---

Use these numbers in any correspondence or service calls concerning your Smart Toilet.

Serial Number

---

If you received a damaged Smart Toilet, immediately contact the dealer (or builder) that sold you the Smart Toilet.

Date of Purchase

---

Purchase Address & Phone

---

Save time and money. Before you call for service, check the Troubleshooting Guide. It lists the causes of minor operating problems that you can correct yourself.

## CUSTOMER SERVICE

Keep the instruction manual handy to answer your questions. If you don't understand something or you need more assistance, please call our Customer Service: 1-866-231-8893

Or email: [mysupport@fornoworld.com](mailto:mysupport@fornoworld.com)

Our contact: CTM Maison Elite Inc.

11420 Albert Hudon, Montréal, Québec H1G 3J6, Canada

The instruction manual can be downloaded from [www.fornoworld.com](http://www.fornoworld.com)





## **CTM Maison Elite Inc.**

11420 Albert Hudon, Montréal, Québec H1G 3J6, Canada  
1-866-231-8893 • [info@CTMMaisonElite.com](mailto:info@CTMMaisonElite.com) • [CTMMaisonElite.com](http://CTMMaisonElite.com)